

VIDEO SPLITTER™

INSTALLATION AND OPERATIONS MANUAL



10707 Stancliff Road
Houston, Texas 77099

Phone (281) 933-7673
WWW.ROSE.COM

LIMITED WARRANTY

Rose Electronics warrants the Video Splitter™ to be in good working order for one year from the date of purchase from Rose Electronics or an authorized dealer. Should this product fail to be in good working order at any time during this one-year warranty period, Rose Electronics will, at its option, repair or replace the Unit as set forth below. Repair parts and replacement units will be either reconditioned or new. All replaced parts become the property of Rose Electronics. This limited warranty is valid only if repairs are performed by Rose Electronics or a Rose qualified service technician. This limited warranty is void if repairs are not performed by Rose Electronics or a Rose qualified service technician. This limited warranty does not include service to repair damage to the Unit resulting from accident, disaster, abuse, or unauthorized modification of the Unit, including static discharge and power surges.

Limited Warranty service may be obtained by delivering this Unit during the one-year warranty period to Rose Electronics or an authorized repair center providing a proof of purchase date. If this Unit is delivered by mail, you agree to insure the Unit or assume the risk of loss or damage in transit, to prepay shipping charges to the warranty service location, and to use the original shipping container or its equivalent. You must call for a return authorization number first. Under no circumstances will a Unit be accepted without a return authorization number. Contact an authorized repair center or Rose Electronics for further information.

ALL EXPRESS AND IMPLIED WARRANTIES FOR THIS PRODUCT INCLUDING THE WARRANTIES OF MERCHANTABILITY AND FITNESS FOR A PARTICULAR PURPOSE, ARE LIMITED IN DURATION TO A PERIOD OF ONE YEAR FROM THE DATE OF PURCHASE, AND NO WARRANTIES, WHETHER EXPRESS OR IMPLIED, WILL APPLY AFTER THIS PERIOD. SOME STATES DO NOT ALLOW LIMITATIONS ON HOW LONG AN IMPLIED WARRANTY LASTS, SO THE ABOVE LIMITATION MAY NOT APPLY TO YOU.

IF THIS PRODUCT IS NOT IN GOOD WORKING ORDER AS WARRANTIED ABOVE, YOUR SOLE REMEDY SHALL BE REPLACEMENT OR REPAIR AS PROVIDED ABOVE. IN NO EVENT WILL ROSE ELECTRONICS BE LIABLE TO YOU FOR ANY DAMAGES INCLUDING ANY LOST PROFITS, LOST SAVINGS OR OTHER INCIDENTAL OR CONSEQUENTIAL DAMAGES ARISING OUT OF THE USE OF OR THE INABILITY TO USE SUCH PRODUCT, EVEN IF ROSE ELECTRONICS OR AN AUTHORIZED DEALER HAS BEEN ADVISED OF THE POSSIBILITY OF SUCH DAMAGES, OR FOR ANY CLAIM BY ANY OTHER PARTY.

SOME STATES DO NOT ALLOW THE EXCLUSION OR LIMITATION OF INCIDENTAL OR CONSEQUENTIAL DAMAGES FOR CONSUMER PRODUCTS, SO THE ABOVE MAY NOT APPLY TO YOU. THIS WARRANTY GIVES YOU SPECIFIC LEGAL RIGHTS AND YOU MAY ALSO HAVE OTHER RIGHTS WHICH MAY VARY FROM STATE TO STATE.

NOTE: This equipment has been tested and found to comply with the limits for a Class A digital device, pursuant to Part 15 of the FCC Rules. These limits are designed to provide reasonable protection against harmful interference when the equipment is operated in a commercial environment. This equipment generates, uses, and can radiate radio frequency energy and, if not installed and used in accordance with the instruction manual, may cause harmful interference to radio communications. Operation of this equipment in a residential area is likely to cause harmful interference in which case the user will be required to correct the interference at his own expense.

IBM®, AT, and PS/2 are trademarks of International Business Machines Corp.
Microsoft® and Microsoft Windows™ are registered trademarks of Microsoft Corp.
Apple, Macintosh, and ADB are trademarks of Apple Computer, Inc.
Sun is a registered trademark of Sun Microsystems Inc.
Any other trademarks mentioned in this manual are acknowledged to be the property of the trademark owner.

Copyright Rose Electronics 1990 – 2006. All rights reserved.
No part of this manual may be reproduced, stored in a retrieval system, or transcribed in any form or any means, electronic or mechanical, including photocopying and recording, without the prior written permission of Rose Electronics.

Rose Electronics Part # MAN-VSP
Printed In the United States of America ■ Revision 2.3

TABLE OF CONTENTS

Contents

Disclaimer.....	1
About this manual.....	1
Introduction.....	1
Features.....	2
Installation – Single Unit.....	5
User operating instructions.....	6
Service Information.....	8
Maintenance and Repair.....	8
Technical Support.....	8
Safety.....	9
Safety and EMC Regulatory Statements.....	10

Figures

Figure 1. Video Splitter Models.....	3
Figure 2. Single Unit configuration.....	5
Figure 3. Video gain switches.....	6

Appendices

Appendix A. General Specifications.....	12
Appendix B. Rack mount.....	13
Appendix C. Rack mount illustration.....	13

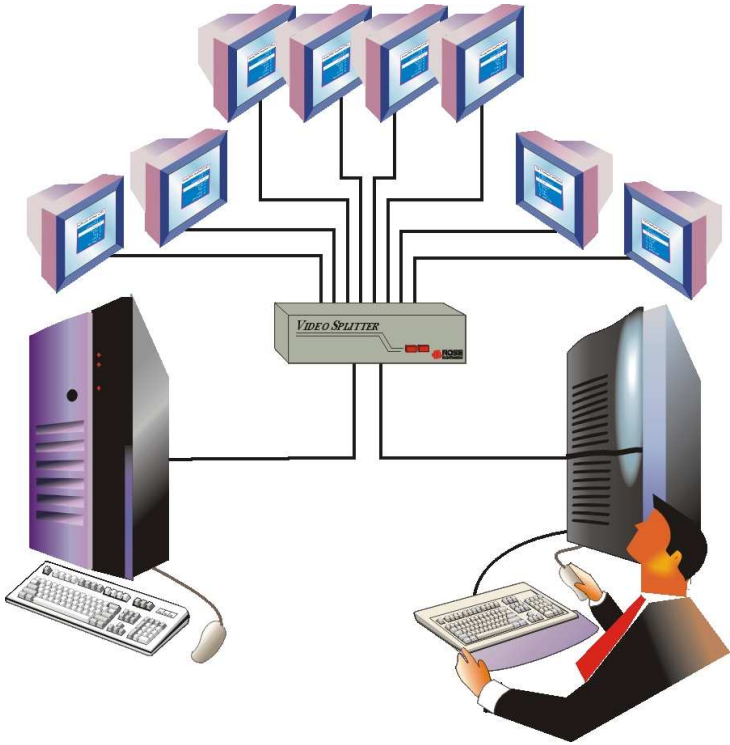

Disclaimer

While every precaution has been taken in the preparation of this manual, the manufacturer assumes no responsibility for errors or omissions. Neither does the manufacturer assume any liability for damages resulting from the use of the information contained herein. The manufacturer reserves the right to change the specifications, functions, or circuitry of the product without notice.

The manufacturer cannot accept liability for damages due to misuse of the product or other circumstances outside the manufacturer's control. The manufacturer will not be responsible for any loss, damage, or injury arising directly or indirectly from the use of this product. (See limited warranty)

About this manual

This manual covers the installation and operations of the Video Splitter.

Introduction

Thank you for choosing the Rose Electronics® Video Splitter™. The Video Splitter is the result of Rose Electronics commitment to providing continued state-of-the-art switching solutions for today's demanding workplace.

The Video Splitter provides a means of splitting the video received from one or two computers and displaying the video on 2, 4, 8, or 16 video monitors. These monitors can be as far away as 250 feet away using our extended distance cables.

The Video Splitter is ideal for classroom applications, conference rooms, point-of-sale, process control, trading floors, airports, restaurants, and security systems. With its expansion features, you can add additional monitors.

Features

- Video resolution up to 1600 x 1280
- Drives multiple monitors from either 1 or 2 computers
- Available in two, four, eight, or sixteen output models
- Ideal for classrooms, conference rooms, point-of-sale presentations, trading room floors, process control, security systems, airports, restaurants, and many other applications
- Daisy-chain units together to expand your system up to 256 monitors or more
- Designed for long cables distances
- Monitors can be located up to 250 feet away from the CPU
- Uses VGA style HD15 connectors
- Optional built in A/B switches on select models allow switching from two CPUs
- Output enable turns off all but port one for private mode viewing

Cable requirements

The cable requirements for your system will vary depending on the number of CPUs (1 or 2) connected to the Video Splitter, the number of remote monitors connected (2, 4, 8, or 16), and the distance each remote monitor is located away from the Video Splitter. (See Appendix B for cable part numbers.)

Package contents

- The Video Splitter
- Power adapter
- Installation and operations manual

Video connection cables and expansion cables are usually ordered and shipped separately. If the package contents are not correct, contact Rose Electronics or your reseller, so the discrepancy can be quickly resolved.

Rose Electronics web site

Visit our web site at www.rose.com for additional information on the Video Splitter and other products offered by Rose Electronics that are designed for data center applications, classroom environments, and many other applications.

MODELS

Models (2, 4, or 8 output ports)



UltraMatrix 2xE – Rear panel

Model number

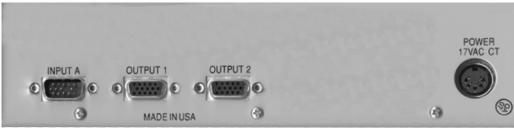

VSP-1X2V

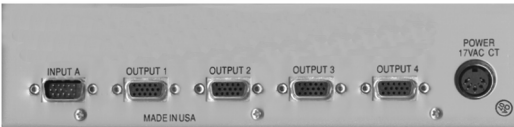

VSP-1X4V

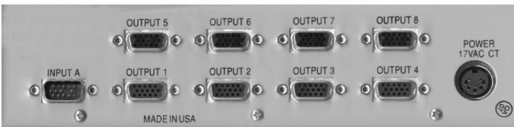

VSP-1X8V

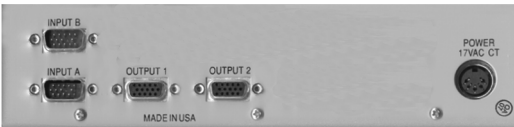

VSP-2X2V

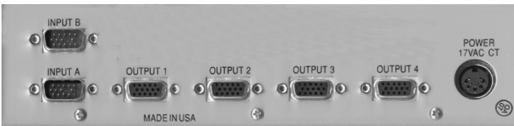

VSP-2X4V

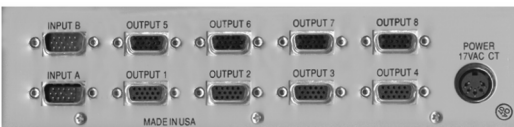

VSP-2X8V

Figure 1. Video Splitter (2, 4, or 8 output) Models

Models (16 output ports)

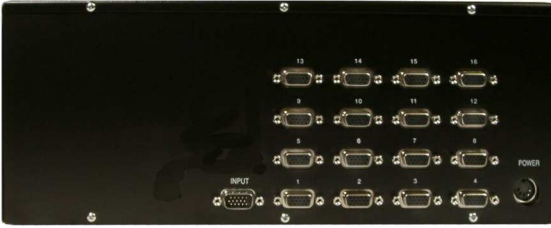

VSP-1X16V

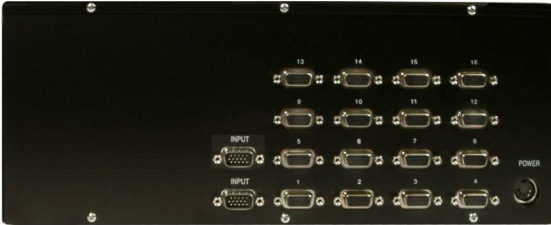

VSP-2X16V

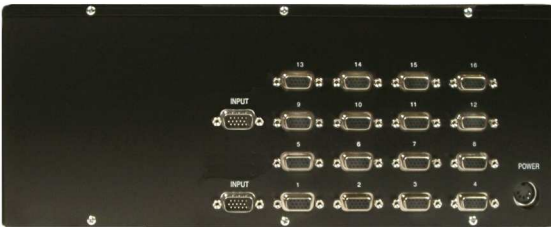

VSP-D1X8

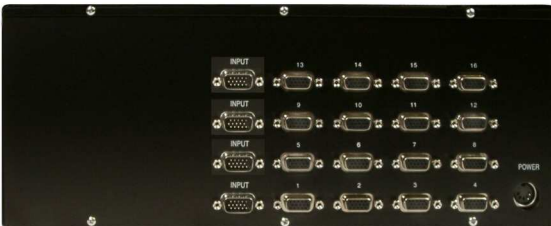

VSP-Q1X4

Figure 2. Video Splitter (16 output) Models

Installation – Single Unit

The basic installation of a single Video Splitter is an easy and straightforward procedure. Perform the below steps for all computers that will be connected. It is recommended that all computers be powered off.

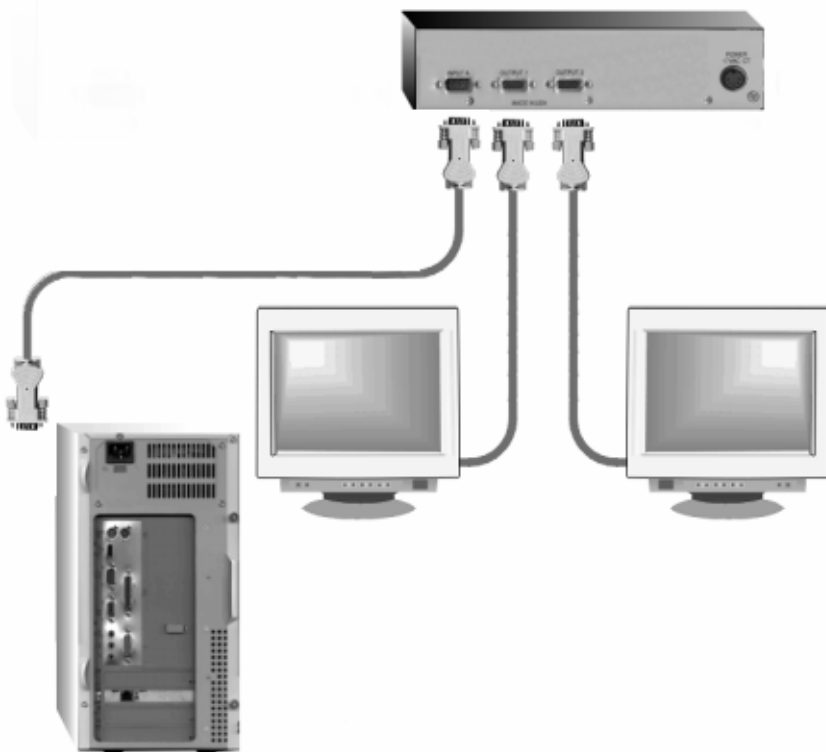

Figure 3. Single Unit configuration

The Unit in Figure 3 can be any Video Splitter model.

User operating instructions

The following instructions apply to all Video Splitter models

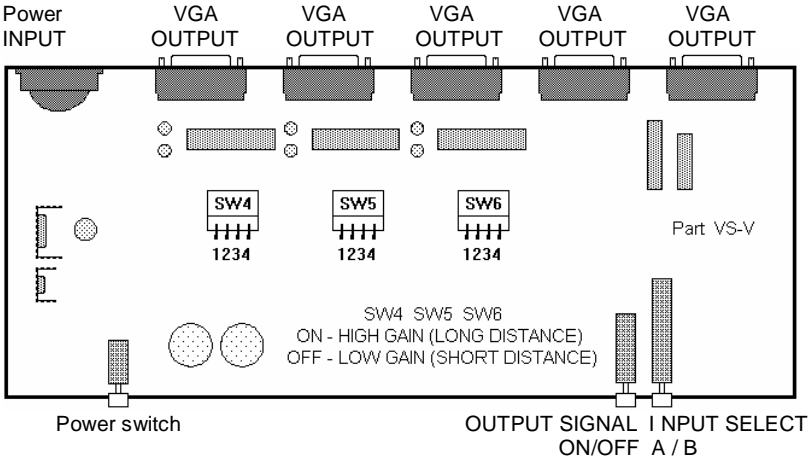

Figure 4. Video gain switches

SWITCHES:

INPUT SELECT A / B

This switch is used to select between the “A” or “B” VGA signal sources.

OUTPUT SIGNAL ON / OFF

This switch is used to blank the output signals on all VGA output ports except port 1

CONNECTORS:

VGA INPUT A / B HD15 Male Connector

Plug the cable from the VGA connector on your CPU into the port connector “A”. A second VGA source connects to port “B”.

VGA OUTPUT HD15 Female Connector

Plug the monitors into these ports (2, 4, or 8)

POWER INPUT

Plug in the provided power adapter into this connector.

Removing the switch cover you can see the 3 banks of DIP switches. The default setting is off (all switches down). The settings are adjusted per port sequentially 1 - 4. Each bank adjusts a different color. SW4 = Red; SW5 = Green; SW6 = Blue;

DIP SWITCH SETTINGS: SW4 = R SW5 = G SW6 = B

These switches are used to adjust the RGB signal clarity (gain) when using higher resolutions or running extended distances. You may experiment by using these switches if your video quality is not as clear as desired.

The VSP-2X8V has two layers of circuit boards. Use a plastic object to switch the DIP switches.

Service Information

Maintenance and Repair

This Unit does not contain any internal user-serviceable parts. In the event a Unit needs repair or maintenance, you must first obtain a Return Authorization (RA) number from Rose Electronics or an authorized repair center. This Return Authorization number must appear on the outside of the shipping container. See Limited Warranty for more information.

When returning a Unit, it should be double-packed in the original container or equivalent, insured and shipped to:

Rose Electronics
Attn: RA _____
10707 Stancliff Road
Houston, Texas 77099 USA

Technical Support

If you are experiencing problems, or need assistance in setting up, configuring or operating your switch, consult the appropriate sections of this manual. If, however, you require additional information or assistance, please contact the Rose Electronics Technical Support Department at:

Phone: (281) 933-7673
E-Mail: TechSupport@rose.com
Web: www.rose.com

Technical Support hours are from: 8:00 am to 6:00 pm CST (USA), Monday through Friday.

Please report any malfunctions in the operation of this Unit or any discrepancies in this manual to the Rose Electronics Technical Support Department.

Safety

This Video Splitter been tested for conformance to safety regulations and requirements, and has been certified for international use. Like all electronic equipment, the Video Splitter should be used with care. To protect yourself from possible injury and to minimize the risk of damage to this Unit, read and follow these safety instructions.

- Follow all instructions and warnings marked on this Unit.
- Except where explained in this manual, do not attempt to service this Unit yourself.
- Do not use this Unit near water.
- Assure that the placement of this Unit is on a stable surface or rack mounted.
- Provide proper ventilation and air circulation.
- Keep power cord and connection cables clear of obstructions that might cause damage to them.
- Use only power cords, power transformer and connection cables designed for this Unit.
- Use only a grounded (three-wire) electrical outlet.
- Keep objects that might damage this Unit and liquids that may spill, clear from this Unit. Liquids and foreign objects might come in contact with voltage points that could create a risk of fire or electrical shock.
- Operate this Unit only when the cover is in place.
- Do not use liquid or aerosol cleaners to clean this Unit. Always unplug this Unit from its electrical outlet before cleaning.
- Unplug this Unit from the electrical outlet and refer servicing to a qualified service center if any of the following conditions occur:
 - The power cord or connection cables is damaged or frayed.
 - The Unit has been exposed to any liquids.
 - The Unit does not operate normally when all operating instructions have been followed.
 - The Unit has been dropped or the case has been damaged.
 - The Unit exhibits a distinct change in performance, indicating a need for service.

Safety and EMC Regulatory Statements

Safety Information



Documentation reference symbol. If the product is marked with this symbol, refer to the product documentation to get more information about the product.

WARNING

A **WARNING** in the manual denotes a hazard that can cause injury or death.

CAUTION

A **CAUTION** in the manual denotes a hazard that can damage equipment.

Do not proceed beyond a **WARNING** or **CAUTION** notice until you have understood the hazardous conditions and have taken appropriate steps.

Grounding

These are Safety Class I products and have protective earthing terminals. There must be an un-interruptible safety earth ground from the main power source to the product's input wiring terminals, power cord, or supplied power cord set. Whenever it is likely that the protection has been impaired, disconnect the power cord until the ground has been restored.

Servicing

There are no user-serviceable parts inside these products. Only service-trained personnel must perform any servicing, maintenance, or repair. The user may adjust only items mentioned in this manual.

Safety and EMC Regulatory Statements

Informations concernant la sécurité



Symbole de référence à la documentation. Si le produit est marqué de ce symbole, reportez-vous à la documentation du produit afin d'obtenir des informations plus détaillées.

WARNING

Dans la documentation, un WARNING indique un danger susceptible d'entraîner des dommages corporels ou la mort.

CAUTION

Un texte de mise en garde intitulé indique un danger susceptible de causer des dommages à l'équipement.

Ne continuez pas au-delà d'une rubrique WARNING ou CAUTION avant d'avoir bien compris les conditions présentant un danger et pris les mesures appropriées.

Cet appareil est un produit de classe I et possède une borne de mise à la terre. La source d'alimentation principale doit être munie d'une prise de terre de sécurité installée aux bornes du câblage d'entrée, sur le cordon d'alimentation ou le cordon de raccordement fourni avec le produit. Lorsque cette protection semble avoir été endommagée, débrancher le cordon d'alimentation jusqu'à ce que la mise à la terre ait été réparée.

Aucune pièce contenue à l'intérieur de ce produit ne peut être réparée par l'utilisateur.

Tout dépannage, réglage, entretien ou réparation devra être confié exclusivement à un personnel qualifié.

APPENDICES

Appendix A. General Specifications

Specification	
Dimensions	8.85"W x 4.90"D x 2.1"H 22.5 x 12.5 x 5.3 cm.
Weight	3lb. / 1.4 kg.
Power	117 VAC to 17 VAC 700ma power adapter
Connectors	Power: DIN5 Video IN: HD15M Video OUT: HD15F
Video bandwidth	250 KHz.
Video sync	Accepts HV, composite, and sync-on-green
Chassis	Electro galvanized steel, painted
Controls	Power On/Off switch Video Dip Switches (1 per video out)
Indicators	LEDs: Power (green) Status (yellow) Send (yellow)
Environmental	0 – 45°C, 0% – 80% RH

Part Number	Description
VSP-1X2VB	1 CPU to 2 Videos
VSP-1X4VB	1 CPU to 4 Videos
VSP-1X8VB	1 CPU to 8 Videos
VSP-1X16V	1 CPU to 16 Videos
VSP-2X2VB	2 CPU to 2 Videos
VSP-2X4VB	2 CPU to 4 Videos
VSP-2X8VB	2 CPU to 8 Videos
VSP-1X2VB/D	Dual 1 CPU to 2 Videos
VSP-1X4VB/D	Dual 1 CPU to 4 Videos
VSP-1X2VB/Q	Quad 1 CPU to 8 Videos
VSP-1X4VB/Q	Quad 1 CPU to 16 Videos
Rack Mount Kit	RM-SV1 RM-SVX16 (For Dual/Quad models)

Appendix B. Rack mount

The optional rack mount kit includes the following items:

- Two black anodized mounting brackets.
- Four 6 - 32 x 3/8" flat head mounting screws.

To rack mount your Video splitter, attach the two rack mounting brackets to your Unit with the short flange against the Unit using the four screws provided. Secure the mounting brackets to the rack using the appropriate size bolts, nuts and lock washers. Using hardware other than that provided could cause damage to the electronics and/or result in loss of mounting integrity. Do not over tighten the screws used to mount the Unit to the mounting brackets.

The following general guidelines should be observed when installing your Unit into a rack.

- a). The Video Splitter is designed to work in an ambient temperature of 0° C to 45° C (32° F – 113° F).
- b). Do not block power supply vents or otherwise restrict airflow when rack-mounting this Unit.
- c). Mechanical loading of the rack should be considered to prevent instability and possible tipping over.
- d). Tighten all connectors securely and provide adequate strain relief for all cables.
- e). Provide a grounded power source to all Units. Pay special attention to overall branch circuit load ratings before connecting equipment to this source. Overloaded circuits are potential fire hazards and can cause equipment failures or poor performance.

Appendix C. Rack mount illustration

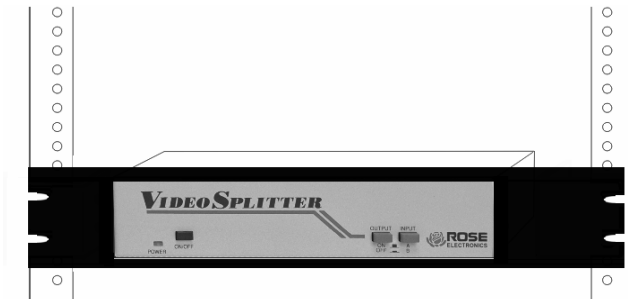



Server Management



Solutions



〒103-0014
東京都中央区日本橋蛸殻町 1-16-11
TEL:03-3668-8089 FAX:03-3668-9872
URL:<http://www.cybernetech.co.jp>